

Ronald M. Case
Professor of Wildlife Biology
Department of Forestry, Fisheries
and Wildlife
University of Nebraska
Lincoln, Nebraska 68583-0819

Bruce A. Jasch
Research Assistant
Department of Forestry, Fisheries
and Wildlife
University of Nebraska
Lincoln, Nebraska 68583-0819

POCKET GOPHERS

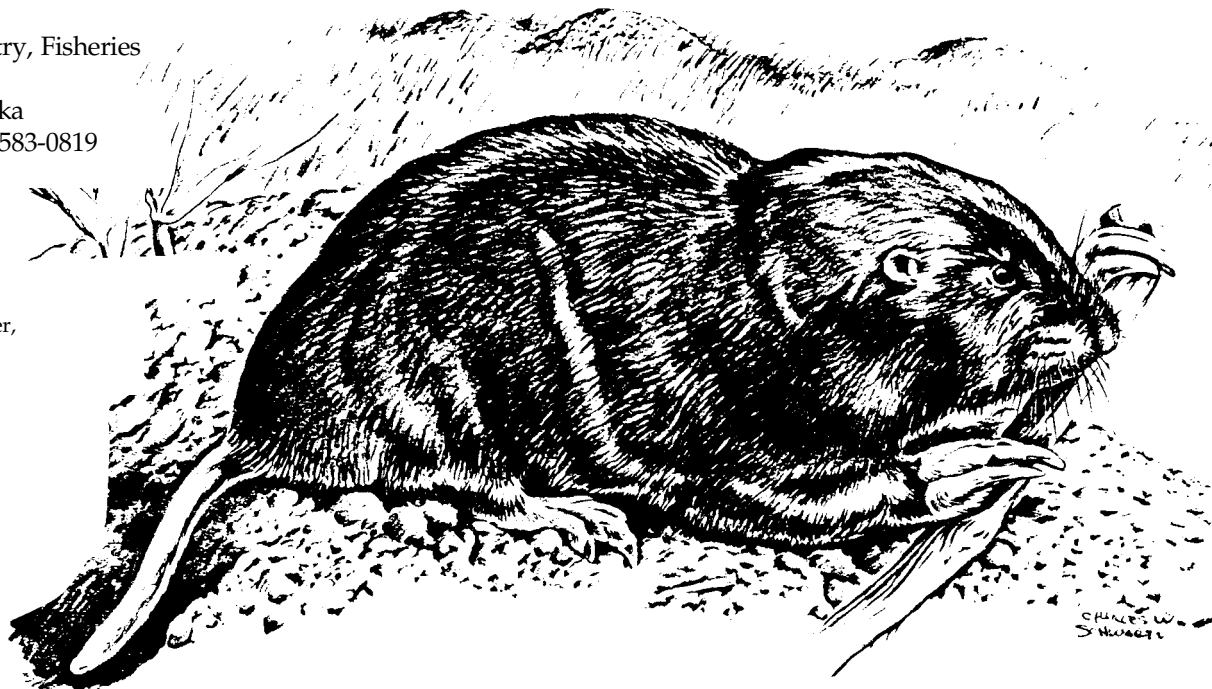

Fig. 1. Plains pocket gopher,
Geomys bursarius

Damage Prevention and Control Methods

Exclusion

Generally not practical.
Small mesh wire fence may provide protection for ornamental trees and shrubs or flower beds.
Plastic netting protects seedlings.

Cultural Methods

Damage resistant varieties of alfalfa.
Crop rotation.
Grain buffer strips.
Control of tap-rooted forbs.
Flood irrigation.
Plant naturally resistant varieties of seedlings.

Repellents

Synthetic predator odors are all of questionable benefit.

Toxicants

Baits:
Strychnine alkaloid.
Zinc phosphide.
Chlorophacinone.
Diphacinone.
Fumigants:
Carbon monoxide from engine exhaust.
Others are not considered very effective, but some are used:
Aluminum phosphide.
Gas cartridges.

Trapping

Various specialized gopher kill traps.
Common spring or pan trap (sizes No. 0 and No. 1).

Shooting

Not practical.

Other

Buried irrigation pipe or electrical cables can be protected with cylindrical pipe having an outside diameter of at least 2.9 inches (7.4 cm).
Surrounding a buried cable with 6 to 8 inches (15 to 20 cm) of coarse gravel (1 inch [2.5 cm] in diameter) may provide some protection.



PREVENTION AND CONTROL OF WILDLIFE DAMAGE — 1994

Cooperative Extension Division
Institute of Agriculture and Natural Resources
University of Nebraska - Lincoln

United States Department of Agriculture
Animal and Plant Health Inspection Service
Animal Damage Control

Great Plains Agricultural Council
Wildlife Committee

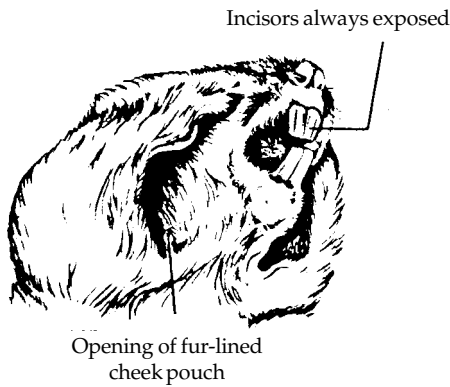

Fig. 2. Pocket gopher characteristics.

Identification

Pocket gophers (Fig. 1) are fossorial (burrowing) rodents, so named because they have fur-lined pouches outside of the mouth, one on each side of the face (Fig. 2). These pockets, which are capable of being turned inside out, are used for carrying food. Pocket gophers are powerfully built in the fore-quarters and have a short neck; the head is fairly small and flattened. The forepaws are large-clawed and the lips close behind their large incisors, all marvelous adaptations to their underground existence.

Gophers have small external ears and small eyes. As sight and sound are severely limited, gophers are highly dependent on the sense of touch. The vibrissae (whiskers) on their face are very sensitive to touch and assist pocket gophers while traveling about in their dark tunnels. The tail is sparsely haired and also serves as a

sensory mechanism guiding gophers' backward movements. The tail is also important in thermoregulation, acting as a radiator.

Pocket gophers are medium-sized rodents ranging from about 5 to nearly 14 inches (13 to 36 cm) long (head and body). Adult males are larger than adult females. Their fur is very fine, soft, and highly variable in color. Colors range from nearly black to pale brown to almost white. The great variability in size and color of pocket gophers is attributed to their low dispersal rate and thus limited gene flow, resulting in adaptation to local conditions.

Thirty-four species of pocket gophers, represented by five genera, occupy the western hemisphere. In the United States there are 13 species and three genera. The major features differentiating these genera are the size of their forefeet, claws, and front surfaces of their chisel-like incisors (Fig. 3).

Thomomys have smooth-faced incisors and small forefeet with small claws. Northern pocket gophers (*Thomomys talpoides*) are typically from 6 1/2 to 10 inches (17 to 25 cm) long. Their fur is variable in color but is often yellowish brown with pale underparts. Botta's (or valley) pocket gophers (*Thomomys bottae*) are extremely variable in size and color. Botta's pocket gophers are 5 inches to about 13 1/2 inches (13 to 34 cm) long. Their color varies from almost white to black.

Geomys have two grooves on each upper incisor and large forefeet and claws. Plains pocket gophers (*Geomys bursarius*) vary in length from almost 7 1/2 to 14 inches (18 to 36 cm). Their fur is typically brown but may vary to black. Desert pocket gophers (*Geomys arenarius*) are always brown and vary from nearly 8 3/4 to 11 inches (22 to 28 cm) long. Texas pocket gophers (*Geomys personatus*) are also brown and are from slightly larger than 8 3/4 to nearly 13 inches (22 to 34 cm) long. Southeastern pocket gophers (*Geomys pinetis*) are of various shades of brown, depending on soil color, and are from 9 to 13 1/4 inches (23 to 34 cm) long.

Pappogeomys have a single groove on each upper incisor and, like *Geomys*, have large forefeet with large claws. Yellow-faced pocket gophers (*Pappogeomys castanops*) vary in length from slightly more than 5 1/2 to just less than 7 1/2 inches (14 to 19 cm). Their fur color varies from pale yellow to dark reddish brown. The underparts vary from whitish to bright yellowish buff. Some hairs on the back and top of the head are dark-tipped.

Range

Pocket gophers are found only in the Western Hemisphere. They range from Panama in the south to Alberta in the north. With the exception of the southeastern pocket gopher, they occur throughout the western two-thirds of the United States.



Thomomys

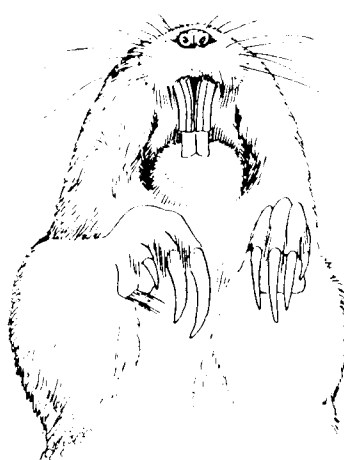

Geomys



Pappogeomys

Fig. 3. These three genera of pocket gophers can be differentiated by relative size of forefeet and front surfaces of upper incisors.

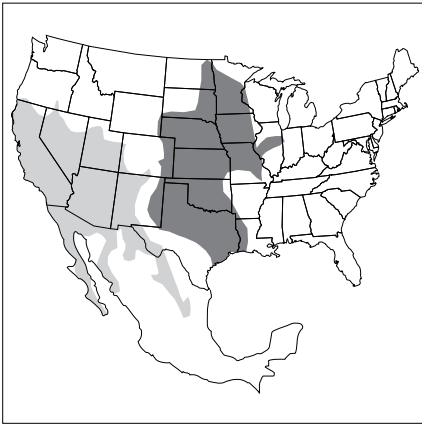

Fig. 4a. Range of the plains pocket gopher (*Geomys bursarius*) (dark) and Botta's pocket gopher (*Thomomys bottae*) (light) in North America.

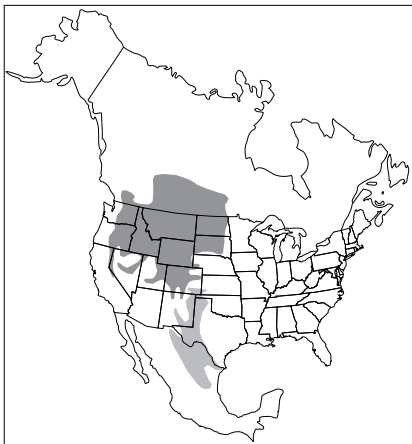

Fig. 4b. Range of the northern pocket gopher (*Thomomys talpoides*) (dark) and yellow-faced pocket gopher (*Pappogeomys castanops*) (light) in North America.



Fig. 4c. Range of the southeastern pocket gopher (*Geomys pinetis*) (dark) and southern pocket gopher (*Thomomys umbrinus*) (light) in North America.

Plains pocket gophers (*Geomys bursarius*, Fig. 4a) are found in the central plains from Canada south through Texas and Louisiana. Botta's (or valley) pocket gophers (*Thomomys bottae*, Fig. 4a) are found in most of the southern half of the western United States.

Northern pocket gophers (*Thomomys talpoides*, Fig. 4b) range throughout most of the states in the northern half of the western United States. Yellow-faced pocket gophers (*Pappogeomys castanops*, Fig. 4b) occur from Mexico, along the western edge of Texas, eastern New Mexico, southwestern Colorado, and into the panhandle of Oklahoma.

Southeastern pocket gophers (*Geomys pinetis*, Fig. 4c) are found in northern and central Florida, southern Georgia, and southeastern Alabama. Southern pocket gophers (*Thomomys umbrinus*, Fig. 4c) range primarily in Central America, but occur in extreme southwestern New Mexico and southeastern Arizona. Desert pocket gophers (*Geomys arenarius*) occur only in southwestern New Mexico and the extreme western edge of Texas. Mazama pocket gophers (*Thomomys mazama*), mountain pocket gophers (*Thomomys monticola*), and Camas pocket gophers (*Thomomys bulbivorus*) have more limited distributions in the extreme western United States.

Habitat

A wide variety of habitats are occupied by pocket gophers. They occur from low coastal areas to elevations in excess of 12,000 feet (3,600 m). Pocket gophers similarly are found in a wide variety of soil types and conditions. They reach their greatest densities on friable, light-textured soils with good herbage production, especially when that vegetation has large, fleshy roots, bulbs, tubers, or other underground storage structures.

The importance of soil depth and texture to the presence or absence of gophers is both obvious and cryptic. Shallow soils may be subject to cave-ins and thus will not maintain a tunnel. Tunnels are deeper in very sandy soils

where soil moisture is sufficient to maintain the integrity of the burrow. A less visible requirement is that atmospheric and exhaled gases must diffuse through the soil to and from the gopher's tunnel. Thus light-textured, porous soils with good drainage allow for good gas exchange between the tunnel and the atmosphere. Soils that have a very high clay content or those that are continuously wet diffuse gases poorly and are unsuitable for gophers.

Pocket gophers sometimes occupy fairly rocky habitats, although those habitats generally do not have more than 10% rocks in the top 8 inches (20 cm) of soil. Pocket gophers appear to burrow around rocks greater than 1 inch (2.5 cm) in diameter, but smaller rocks are frequently pushed to the surface.

Soil depth is also important in ameliorating temperatures. Soils less than 4 inches (10 cm) deep probably are too warm during summers. Shallow tunnels may also limit the presence of gophers during cold temperatures, especially if an insulating layer of snow is absent.

Typically, only one species of pocket gopher is found in each locality. Soil factors are important in limiting the distributions of pocket gophers. The larger gophers are restricted to sandy and silty soils east of the Rockies. Smaller gophers of the genus *Thomomys* have a broader tolerance to various soils.

Food Habits

Pocket gophers feed on plants in three ways: 1) they feed on roots that they encounter when digging; 2) they may go to the surface, venturing only a body length or so from their tunnel opening to feed on aboveground vegetation; and 3) they pull vegetation into their tunnel from below. Pocket gophers eat forbs, grasses, shrubs, and trees. They are strict herbivores, and any animal material in their diet appears to result from incidental ingestion.

Alfalfa and dandelions are apparently some of the most preferred and nutri-

tious foods for pocket gophers. Generally, *Thomomys* prefer perennial forbs, but they will also eat annual plants with fleshy underground storage structures. Plains pocket gophers consume primarily grasses, especially those with rhizomes, but they seem to prefer forbs when they are succulent in spring and summer.

Portions of plants consumed also vary seasonally. Gophers utilize above-ground portions of vegetation mostly during the growing season, when the vegetation is green and succulent. Height and density of vegetation at this time of year may also offer protection from predators, reducing the risk of short surface trips. Year-round, however, roots are the major food source. Many trees and shrubs are clipped just above ground level. This occurs principally during winter under snow cover. Damage may reach as high as 10 feet (3 m) above ground. Seedlings also have their roots clipped by pocket gophers.

General Biology, Reproduction, and Behavior

Just as cheek pouches are used in identification of pocket gophers, their fan-shaped soil mounds are characteristic evidence of their presence. Typically, there is only one gopher per burrow system. Obvious exceptions are when mating occurs and when the female is caring for her young.

All pocket gophers use their claws and teeth while digging. *Geomys*, however, are primarily claw diggers, while *Thomomys* do much more tooth digging, and *Pappogeomys* are intermediate between the two. Soil, rocks, and other items loosened by this means are kicked away from the digging area with the hind feet. Gophers then turn over, making a sort of somersault within the confines of their burrow, and use their forefeet and chest to push the materials out of the burrow.

The incisors of pocket gophers, as in all rodents, grow continuously to repair the wear and tear on the teeth. On the other hand, gophers must gnaw con-

tinuously to keep their teeth ground to an appropriate length. Gophers exert tremendous pressure with their bite, up to 18,000 pounds per square inch (1,265 kg/cm²).

Burrow systems consist of a main burrow, generally 4 to 18 inches (10 to 46 cm) below and parallel to the ground surface, with a variable number of lateral burrows off the main one. These end at the surface with a soil mound or sometimes only a soil plug. There are also deeper branches off the main burrow that are used as nests and food caches. Enlargements along the main tunnel are probably feeding and resting locations. Nest chambers have dried grasses and other grasslike plants formed into a sphere. The maximum depth of at least some portion of a burrow may be as great as 5 or 6 feet (1.5 or 1.8 m). The diameter of a burrow is about 3 inches (7.6 cm) but varies with the body size of the gopher.

Burrow systems may be linear or highly branched. The more linear systems may be those of reproductive males, since this shape would increase the likelihood of encountering a female's burrow. The number of soil mounds on the surface of the ground may be as great as 300 per animal in a year. Burrows are sometimes quite dynamic, with portions constantly being sealed off and new areas excavated. A single burrow system may contain up to 200 yards (180 m) of tunnels. The poorer the habitat, the larger the burrow system required to provide sufficient forage for its occupant.

The rate of mound building is highly variable. Estimates include an average of 1 to 3 per day up to 70 mounds per month. This activity brings large amounts of soil to the surface, variously estimated at 2 1/4 tons (2 mt) per gopher each year up to 46 3/4 tons per acre (103.9 mt/ha) for a population of 50 southern pocket gophers.

The tunnel system tells us much about its inhabitant. The system is rigorously defended against intruders and constitutes the home range of the pocket gopher, which may be up to 700 square yards (560 m²).

Pocket gophers also tunnel through snow, above the ground. Soil from below ground is pushed into the snow tunnels, but mounds are not built. When the snow melts, the soil casts (tubes) remain on the ground until they weather away. Soil casts are left by both *Thomomys* and *Geomys* in areas where snow cover is adequate for burrowing.

Pocket gophers do not hibernate. Some observers believe their activities peak at dawn and dusk, but various studies have shown them to be active throughout the day, with activity periods interspersed with rest. Mound building by plains pocket gophers increases in spring, frequently declines during summer, and increases again in fall. In *Thomomys*, mound building increases from spring through summer into fall. Tunneling underground is a tremendously demanding activity estimated to require 360 to 3,400 times the energy of moving across the surface. Thus, this activity must be of great importance to the pocket gopher's survival, either increasing its chance of breeding or finding needed food resources.

Pocket gophers reach sexual maturity in the spring following their birth. In the northern part of their range they have 1 litter per year. In the southern portion they may have 2 litters per year. One researcher has suggested that *Thomomys* in irrigated alfalfa in California may breed throughout the year.

Litter sizes range from 1 to 10 but typically average 3 to 4. In some southern portions of their range where 2 litters are born each year, litter size is usually smaller, averaging about 2. The breeding season also varies, but births typically occur from March through June. The gestation period is 18 or 19 days for the northern pocket gopher, but periods as long as 51 days for the plains pocket gopher have been reported. Sex ratios are typically in favor of females, generally ranging from 55% to 60% females for *Geomys*. In *Thomomys*, the sex ratio is often 50:50 but it varies seasonally. There may be more males than females in spring and the reverse for summer and

fall. Pocket gophers have been thought to be polygamous (one male mating with two or more females), but serial monogamy may be the case. The male cohabits a tunnel system and may help care for young before moving on to another female's burrow system. Some researchers believe both sexes move mainly underground from their own to other burrows during the breeding season.

Densities reported for various pocket gophers are highly variable. Densities of 16 to 20 per acre (40 to 49/ha) are very common for *Thomomys*, but they may attain densities up to 62 per acre (153/ha). For *Geomys*, 6 to 8 per acre (20/ha) are representative of high densities. Average life span of gophers appears to change inversely with population density. Average longevity for *Thomomys* ranges from just over 1 year to nearly 3 years. *Geomys* may live to an average age of 2 and reach a maximum age in the wild in excess of 7 years.

Sharp declines in gopher populations have been noted on several occasions. Usually some climatic factor is associated with a marked decline. An example would be a heavy snow cover, then rapid snowmelt with a concomitant rise in the water table.

External parasites are often found on pocket gophers. Lice are perhaps the most common, while ticks, fleas, and mites also occur. The contribution of parasites to gopher mortality is unknown.

Numerous predators eat pocket gophers. Some of the predators pursue the gopher in its tunnel system (weasels, perhaps spotted skunks, and several snakes including gopher, bull, and rattlesnakes). Badgers are adept at digging out gophers, and a whole host of predators prey on gophers when they are aboveground feeding, dispersing, or while they construct their mounds. Other mammalian predators include coyotes, domestic dogs, foxes, house cats, striped skunks, and bobcats. Raptors that prey on gophers include several owls, especially great horned and barn owls, and several hawks.

A great diversity of vertebrates has been found in the burrows of pocket gophers. It is especially interesting to note how gophers react to those animals. Most amphibians and lizards are largely ignored. Ground squirrels, kangaroo rats, and smaller rodents generally avoid gophers, frequently leaving the tunnel system if occupied by a gopher. Sometimes gophers block the exit of these rodents by constructing earthen plugs in the burrow system. When pocket gophers encounter snakes, weasels, or other threats, they typically react by assuming a threatening posture with the mouth open, vocalizing with panting sounds, and raising the front of the body slightly with their claws extended forward. This behavior usually chases away other gophers in the tunnel. If the intruder is a snake, many strikes bounce off the gopher's incisors and claws. In addition, the gopher may try to block the intruder with a wall of soil.

Pocket gophers are capable of swimming. The southern pocket gopher has the greatest endurance of three species that were tested in laboratory conditions. The plains pocket gopher is intermediate in its endurance between the southern pocket gopher and the yellow-faced pocket gopher. The latter is a very poor swimmer. The superior swimming ability of the southern pocket gopher may be an adaptation to its mountain habitat, which frequently undergoes flooding during snowmelt. Swimming during flooding may also be a method of pocket gopher dispersal.

Dispersal of young plains pocket gophers from their natal burrows has been reported to begin in June in Colorado. Young apparently begin to disperse when they are only one-third the adult body size. Other indications of aboveground dispersal of pocket gophers have been reported by incidental captures of gophers in drift fences set for snakes. A plains pocket gopher was reported a victim of an automobile on a highway in Iowa, and plains pocket gophers are reported falling into window wells every

summer in Nebraska. These aboveground movements are a prime reason for high mortality in densely populated areas.

Damage and Damage Identification

Several mammals are sometimes confused with pocket gophers because of variations in common local terminology (Fig. 5). In addition, in the southeastern United States, pocket gophers are called "salamanders," (derived from the term *sandy moulder*), while the term *gopher* refers to a tortoise. Pocket gophers can be distinguished from the other mammals by their tell-tale signs as well as by their appearance. Pocket gophers leave soil mounds on the surface of the ground. The mounds are usually fan-shaped and tunnel entrances are plugged, keeping various intruders out of burrows.

Damage caused by gophers includes destruction of underground utility cables and irrigation pipe, direct consumption and smothering of forage by earthen mounds, and change in species composition on rangelands by providing seedbeds (mounds) for invading annual plants. Gophers damage trees by stem girdling and clipping, root pruning, and possibly root exposure caused by burrowing. Gopher mounds dull and plug sicklebars when harvesting hay or alfalfa, and soil brought to the surface as mounds is more likely to erode. In irrigated areas, gopher tunnels can channel water runoff, causing loss of surface irrigation water. Gopher tunnels in ditch banks and earthen dams can weaken these structures, causing water loss by seepage and piping through a bank or the complete loss or washout of a canal bank. The presence of gophers also increases the likelihood of badger activity, which can also cause considerable damage.

Legal Status

Pocket gophers are not protected by federal or state law.

Damage Prevention and Control Methods

Exclusion

Because of the expense and limited practicality, exclusion is of little use. Fencing of highly valued ornamental shrubs or landscape trees may be justified. The fence should be buried at least 18 inches (46 cm). The mesh should be small enough to exclude gophers: 1/4-inch or 1/2-inch (6- to 13-mm) hardware cloth will suffice. Cylindrical plastic netting placed over the entire seedling, including the bare root, reduces damage to newly planted forest seedlings significantly.

Cultural Methods and Habitat Modification

These methods take advantage of knowledge of the habitat requirements of pocket gophers or their feeding behavior to reduce or eliminate damage.

Crop Varieties. In alfalfa, large tap-rooted plants may be killed or the vigor of the plant greatly reduced by pocket gophers feeding on the roots. Varieties with several large roots rather than a single taproot suffer less when gophers feed on them. Additionally, pocket gophers in alfalfa fields with fibrous-root systems may have smaller ranges. This would reduce gopher impact on yield.

Crop Rotation. There are many good reasons for using a crop rotation scheme, not the least of which is minimizing problems with pocket gophers. When alfalfa is rotated with grain crops, the resultant habitat is incapable of supporting pocket gophers. The annual grains do not establish large underground storage structures and thus there is insufficient food for pocket gophers to survive year-round.

Grain Buffer Strips. Planting 50-foot (15-m) buffer strips of grain around hay fields provides unsuitable habitat around the fields and can minimize immigration of gophers.

Weed Control. Chemical or mechanical control of forbs, which frequently

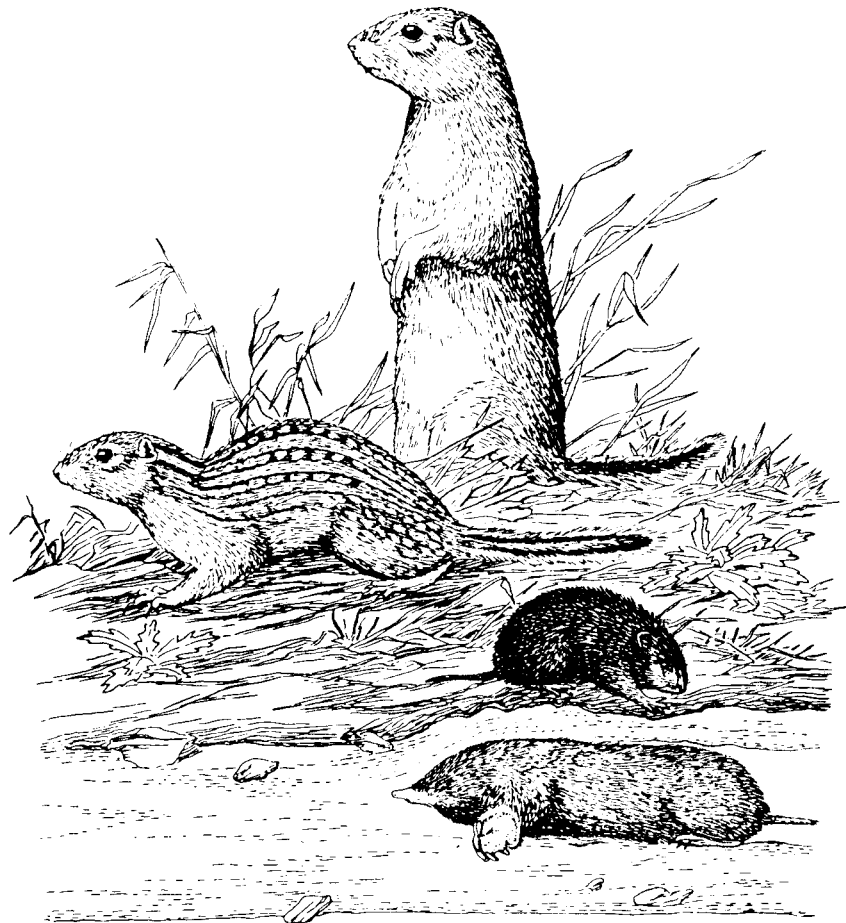

Fig. 5. Mammals that are sometimes called gophers. From top to bottom: Richardson ground squirrel, thirteen-lined ground squirrel, vole, and mole.

have large underground storage structures, can be an effective method of minimizing damage by *Thomomys* to rangelands. It may also be effective in making orchards and shelterbelts less suitable for pocket gophers. The method is less effective for plains pocket gophers as they survive quite nicely on grasses. The warm-season prairie grasses have large root-to-stem ratios and these food sources are adequate for *Geomys*.

Flood Irrigation. Irrigating fields by flooding can greatly reduce habitat suitability for pocket gophers. Water can fill a gopher's tunnel, thus causing the occupant to drown or flee to the surface, making it vulnerable to predation. The soil may be so damp that it becomes sticky. This will foul the pocket gopher's fur and claws. As the soil becomes saturated with water, the diffusion of gases into and out of the

gopher's burrow is inhibited, creating an inhospitable environment. The effectiveness of this method can be enhanced by removing high spots in fields that may serve as refuges during irrigation.

Damage-Resistant Plant

Varieties. Tests of several provenances of ponderosa pine showed that some have natural resistance to gopher damage.

Repellents

Some predator odors have been tested as gopher repellents and show some promise. Commercially available sonic devices are claimed to repel pocket gophers. There is, however, no scientific supporting evidence. The plants known as caper spurge, gopher purge, or mole plant (*Euphorbia lathyris*) and the castor-oil plant (*Ricinus communis*) have been promoted as gopher

repellents, but there is no evidence of their effectiveness. In addition, these are not recommended as they are both poisonous to humans and pets.

Toxicants

Several rodenticides currently are federally registered and available for pocket gopher control. The most widely used and evaluated is strychnine alkaloid (0.25 to 0.5% active ingredient) on grain baits. There is some concern that pocket gophers may consume sublethal doses of strychnine and then develop bait shyness. Strychnine acts very rapidly and gophers sometimes die within an hour after consuming a lethal dose. It is registered for use for *Geomys* spp. and *Thomomys* spp. If the label has directions for use with a burrow builder machine, then it is a Restricted Use Pesticide. Zinc phosphide (2%) is less effective than strychnine for gopher control. Anticoagulants now are available for pocket gopher control. Currently, the only federally registered products are chlorophacinone and diphacinone.

To poison pocket gophers, the bait must be placed in their tunnel systems by hand or by a special machine known as a burrow builder. Underground baiting for pocket gopher control with strychnine presents minimal hazards to nontarget wildlife, either by direct consumption of bait or by eating poisoned gophers. Poison bait spilled on the surface of the ground may be hazardous to ground-feeding birds such as mourning doves.

The main drawback to grain baits is their high susceptibility to decomposition in the damp burrows. A new product that contains a grain mixture plus the anticoagulant, diphacinone, in a paraffin block not only increases the bait's effective life, but also makes it possible for more than one gopher to be killed with the same bait. Once the resident gopher ingests the toxicant and dies, it is typical for a neighboring gopher to take over the tunnel system and thus to ingest the still-toxic bait.

Hand Baiting. Bait can be placed in a burrow system by hand, using a

special hand-operated bait dispenser probe, or by making an opening to the burrow system with a probe. Placing bait in the burrow by hand is more time-consuming than either of the probing methods, but there is no doubt that the bait is delivered to the tunnel system.

The key to efficient and effective use of these methods is locating the burrow system. The main burrow generally is found 12 to 18 inches (30 to 46 cm) away from the plug on the fan-shaped mounds (Fig. 6). If you use a trowel or shovel to locate the main burrow, dig 12 to 18 inches (30 to 46 cm) away from the plug. When the main burrow is located, place a rounded tablespoon (15 ml) of bait in each direction. Place the bait well into each tunnel system with a long-handled spoon and then block off each tunnel with sod clumps and soil. Bait blocks are also applied in this manner. The reason for closing the burrow is that pocket gophers are attracted to openings in their system with the intent of closing them with soil. Thus, if there is a detectable opening near the placement of poison, the pocket gopher may cover the bait with soil as it plugs the opening. Pocket gophers normally travel all portions of their burrow system during a day.

Place a probe for pocket gopher tunnels where you expect to locate the main burrow as described above (plans for making a probe and instruc-

tions for use are presented in figure 7). You will know you have located a burrow by the decreased friction on the probe. With a reservoir-type bait probe dispenser (Fig. 8), a button is pushed when the probe is in a burrow and a metered dose of bait drops into the burrow. With the burrow probe (without a bait reservoir), make an opening from the surface of the ground to the burrow. Place about a tablespoon (15 ml) of bait down the probe opening. This method is much quicker than digging open the burrow tunnel. For best control, dose each burrow system in two or three places. Be sure to cover the probe hole with a sod clump so that the pocket gopher does not cover the bait when attracted to the opening in its burrow. Greater doses of chlorophacinone or other locally registered anticoagulants are recommended (1/2 cup [120 ml]) at each of two or three locations in each burrow. Also, since some gophers poisoned in this manner die aboveground, the area should be checked periodically for 10 to 14 days after treatment. Any dead gophers found should be buried or incinerated.

Mechanical Burrow Builder. The burrow builder (Fig. 9) delivers bait underground mechanically, so large areas can be economically treated for pocket gopher control. It is tractor-drawn and is available in hydraulically operated units or three-point hitch models.

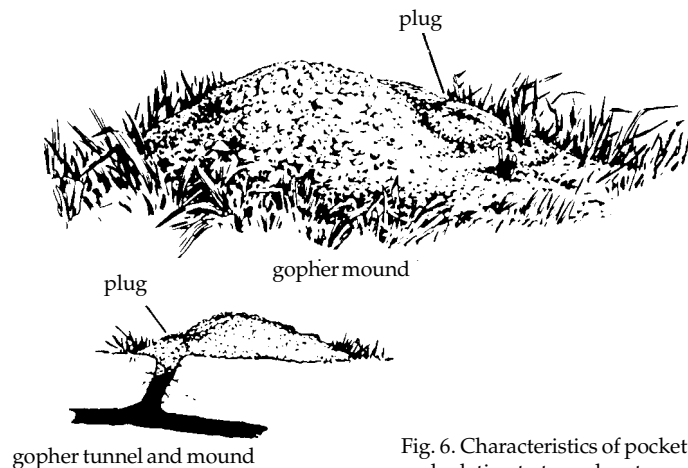
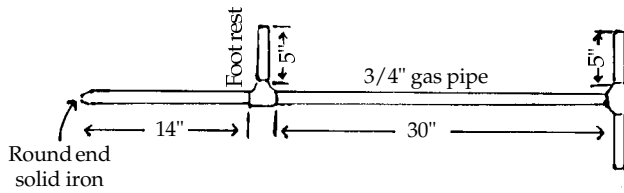

Fig. 6. Characteristics of pocket gopher mounds and relation to tunnel system.

Fig. 7. Materials and construction plans for pocket gopher probes.

For extensive use in relatively soft soil, a durable probe may be made of 3/4-inch gas pipe—1 piece 30 inches long. The 30-inch piece is threaded at both ends and the other pieces at one end only. A piece of 1/2-inch round iron about 2 inches long is welded into the unthreaded end of the 14-inch pipe and bluntly pointed. The pieces are then arranged and fitted together with two 3/4-inch T-joints as shown here.



For use in hard soil, the probe may be made of the following materials:

- 1 piece of 1/2-inch galvanized pipe, 34 inches long
- 1 piece of 1/2-inch galvanized pipe, 5 inches long
- 1 1/2-inch galvanized T-joint
- 1 piece of 1/2-inch round iron, 2 inches long
- 1 piece of highly tempered steel, 3/8-inch in diameter and 28 inches long
- 1 3/8-inch set screw, 1 inch long
- 1 3/8-inch nut
- 1 reducer, 1/2 inch to 3/8 inch

The two pieces of pipe are each threaded at one end. The piece of round iron is welded into the unthreaded end of the 34-inch pipe and bluntly pointed. A 3/8-inch hole is bored in the T-joint, and the 3/8-inch nut is brazed over this hole to accommodate the set screw. The piece of highly tempered steel is sharply pointed on one or both ends and held in place by the set screw. The pointed end of a hayrake tooth cut 28 inches long would serve well for this piece. These materials are then assembled as shown here.

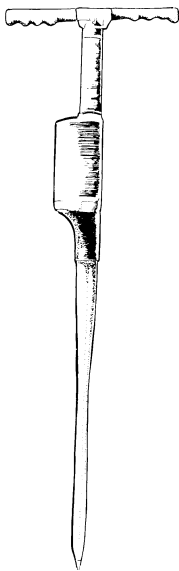
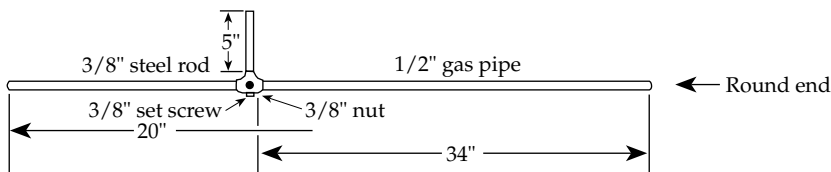

Fig. 8. Automatic bait dispensing probe for pocket gopher control.

The device consists of a knife and torpedo assembly that makes the artificial burrow at desired soil depths, a coulter blade that cuts roots of plants ahead of the knife, a seeder assembly for bait dispensing, and the packer wheel assembly to close the burrow behind the knife. The seeder box has a metering device for dispensing various toxic baits at desired rates.

The artificial burrows should be constructed at a depth similar to those constructed by gophers in your area. The artificial burrows may intercept the gopher burrows, or the gophers may inquisitively enter the artificial burrows, gather bait in their cheek pouches, and return to their burrow

system to consume the bait. Recommended application rates of 1 to 2 pounds per acre (1.1 to 2.2 kg/ha) of 0.3 to 0.5% strychnine alkaloid grain should provide an 85% to 95% reduction in the gopher population (Table 1 demonstrates how to calculate bait delivery rates).

The burrows should be spaced at 20- to 25-foot (6- to 8-m) intervals. To assure success:

1. Operate the burrow builder parallel to the ground surface, at a depth where gophers are active. It is essential to check the artificial burrow. If the soil is too dry, a good burrow will not be formed; if the soil is too wet and sticky, soil will accumulate on packer wheels or even on the knife shank and the slot may not close adequately.
2. Check periodically to note whether bait is being dispensed. Sometimes the tube gets clogged with soil.
3. Encircle the perimeter of the field with artificial burrows to deter reinvasions.
4. Follow directions provided with the burrow builder machine.

It is especially important to scour the torpedo assembly by pulling it through sandy soils so that smooth burrows will be constructed.

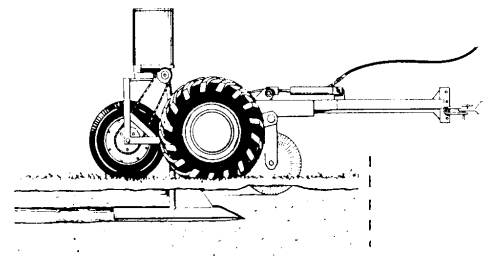

Fig. 9. A tractor-drawn mechanical burrow builder machine can be used to control pocket gophers. It automatically dispenses toxic bait into the artificial burrow it creates.

Table 1. Burrow builder machine bait application rate chart.

When bait-metering device is adjusted to deliver:	Spacing between rows of artificial burrows (feet)													
	10	12	14	16	18	20	22	24	26	28	30	32	34	36
Pounds/1,000 feet of burrow	Pounds of bait delivered per acre													
0.1	0.44	0.36	0.31	0.27	0.24	0.22	0.20	0.18	0.17	0.16	0.15	0.14	0.13	0.12
0.2	0.87	0.73	0.62	0.54	0.48	0.44	0.40	0.36	0.34	0.31	0.29	0.27	0.26	0.24
0.3	1.30	1.10	0.93	0.82	0.73	0.65	0.59	0.54	0.50	0.47	0.44	0.41	0.38	0.36
0.4	1.70	1.50	1.20	1.10	0.97	0.87	0.79	0.73	0.67	0.62	0.58	0.54	0.51	0.48
0.5	2.20	1.80	1.60	1.40	1.20	1.10	0.99	0.91	0.84	0.78	0.73	0.68	0.64	0.61
0.6	2.60	2.20	1.90	1.60	1.50	1.30	1.20	1.10	1.00	0.93	0.87	0.82	0.77	0.73
0.7	3.00	2.50	2.20	1.90	1.70	1.50	1.40	1.30	1.20	1.10	1.00	0.95	0.90	0.85
0.8	3.50	2.90	2.50	2.20	1.90	1.70	1.60	1.50	1.30	1.20	1.20	1.10	1.00	0.97
0.9	3.90	3.30	2.80	2.50	2.20	2.00	1.80	1.60	1.50	1.40	1.30	1.20	1.20	1.10
1.0	4.40	3.60	3.10	2.70	2.40	2.20	2.00	1.80	1.70	1.60	1.50	1.40	1.30	1.20
1.1	4.80	4.00	3.40	3.00	2.70	2.40	2.20	2.00	1.80	1.70	1.60	1.50	1.40	1.30
1.2	5.20	4.40	3.70	3.30	2.90	2.60	2.40	2.20	2.00	1.90	1.70	1.60	1.50	1.50
1.3	5.70	4.70	4.00	3.50	3.10	2.80	2.60	2.40	2.20	2.00	1.90	1.80	1.70	1.60
1.4	6.10	5.10	4.40	3.80	3.40	3.00	2.80	2.50	2.30	2.20	2.00	1.90	1.80	1.70
1.5	6.50	5.40	4.70	4.10	3.60	3.30	3.00	2.70	2.50	2.30	2.20	2.00	1.90	1.80
1.6	7.00	5.80	5.00	4.40	3.90	3.50	3.20	2.90	2.70	2.50	2.30	2.20	2.00	1.90
1.7	7.40	6.20	5.30	4.60	4.10	3.70	3.40	3.10	2.80	2.60	2.50	2.30	2.20	2.10
1.8	7.80	6.50	5.60	4.90	4.40	3.90	3.60	3.30	3.00	2.80	2.60	2.40	2.30	2.20
1.9	8.30	6.90	5.90	5.20	4.60	4.10	3.80	3.40	3.20	3.00	2.80	2.60	2.40	2.30
2.0	8.70	7.30	6.20	5.40	4.80	4.40	4.00	3.60	3.40	3.10	2.90	2.70	2.60	2.40
2.1	9.10	7.60	6.50	5.70	5.10	4.60	4.20	3.80	3.50	3.30	3.00	2.90	2.70	2.50
2.2	9.60	8.00	6.80	6.00	5.30	4.80	4.40	4.00	3.70	3.40	3.20	3.00	2.80	2.70
2.3	10.00	8.30	7.20	6.30	5.60	5.00	4.60	4.20	3.90	3.60	3.30	3.10	2.90	2.80
2.4	10.50	8.70	7.50	6.50	5.80	5.20	4.80	4.40	4.00	3.70	3.50	3.30	3.10	2.90
2.5	10.90	9.10	7.80	6.80	6.10	5.40	5.00	4.50	4.20	3.90	3.60	3.40	3.20	3.00
2.6	11.30	9.40	8.10	7.10	6.30	5.70	5.10	4.70	4.40	4.00	3.80	3.50	3.30	3.10
2.7	11.80	9.80	8.40	7.40	6.50	5.90	5.30	4.90	4.50	4.20	3.90	3.70	3.50	3.30
2.8	12.20	10.20	8.70	7.60	6.80	6.10	5.50	5.10	4.70	4.40	4.10	3.80	3.60	3.40
2.9	12.60	10.50	9.00	7.90	7.00	6.30	5.70	5.30	4.90	4.50	4.20	3.90	3.70	3.50
3.0	13.10	10.90	9.30	9.20	7.30	6.50	5.90	5.40	5.00	4.70	4.40	4.10	3.80	3.60

EXAMPLE: To determine the amount of bait that will be delivered if a mechanical baiter is set to apply 0.5 pound per 1,000 feet of burrow, and is to be used between orchard rows with 22-foot spacings, read down row spacing column 22 until opposite the designated 0.5 pound. The answer (to the nearest hundredth) is 0.99 pound.

Fumigants

Federally registered fumigants include aluminum phosphide and gas cartridges with various active ingredients. These fumigants usually are not very successful in treating pocket gophers because the gas moves too slowly through the tunnel system. Unless the soil is moist, the fumigant will diffuse through the soil out of the gopher’s tunnel.

Carbon monoxide from automobile exhaust is more effective than other fumigants because of its greater volume and pressure. Connect a piece of

hose or pipe to the engine exhaust, and place it in a tunnel near a fresh soil mound. Pack soil around the hose or pipe and allow the engine to run for about 3 minutes. The method is usually 90% effective. The engines of newer vehicles with antipollution devices require a longer running time since they do not produce as much carbon monoxide. This procedure requires no registration.

Trapping

Trapping is extremely effective for pocket gopher control in small areas

and for removal of remaining animals after a poisoning control program. Some representative traps are illustrated on the following page (Fig. 10) with instructions for setting them (Figs. 11 and 12).

Vulnerability to trapping differs among species of pocket gophers and sometimes within the same species in different areas and at different times of the year.

For effective trapping, the first requisite is to find the tunnel. The procedure will vary depending on whether

Fig. 10. Common types of traps for pocket gophers.

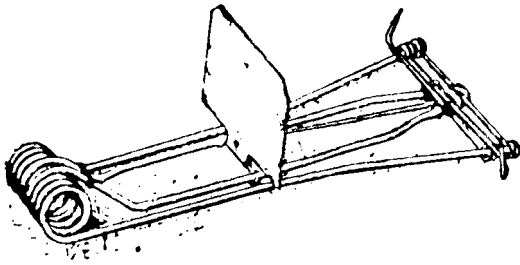

(a) Macabee® gopher trap

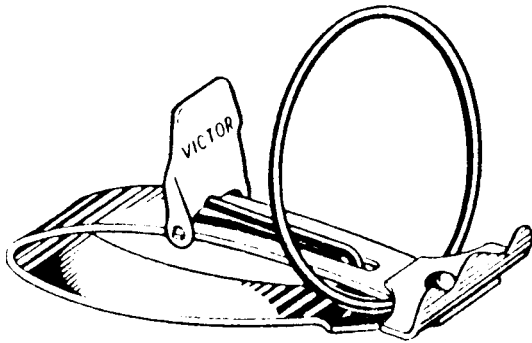

(b) Victor® Gopher Getter

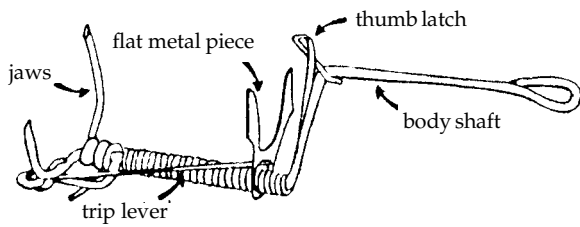

(c) Death-Klutch 1 gopher and mole trap

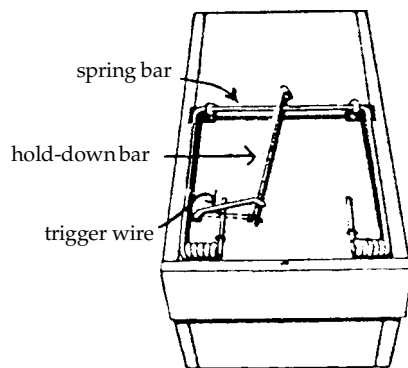

(d) Guardian (California box-type) gopher trap

Fig. 11. Instructions for setting Macabee®.

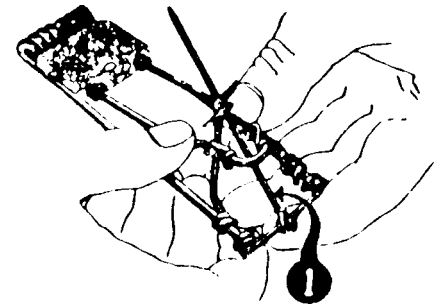

Hold trap exactly as shown. Be sure left index finger holds trigger (1) in upright position.

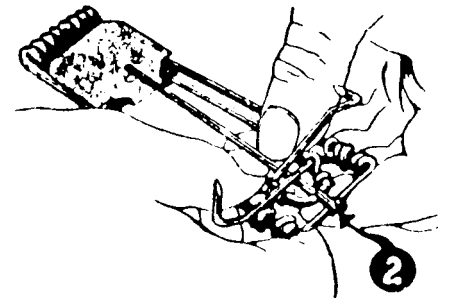

Press thumbs down, and with left index finger guide hook on trigger (2) over end of frame of trap.

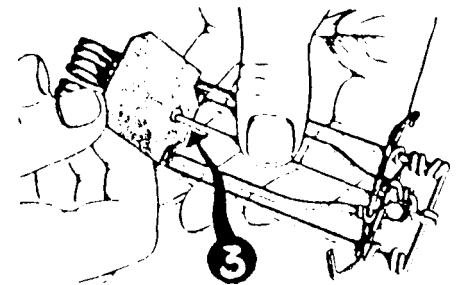

Still holding frame down, place other end of trigger (3) into small hole in plate.

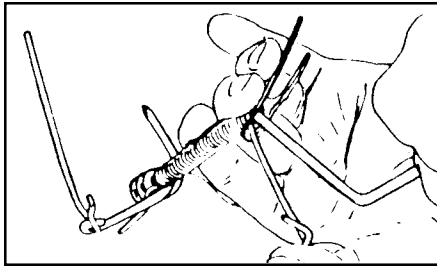
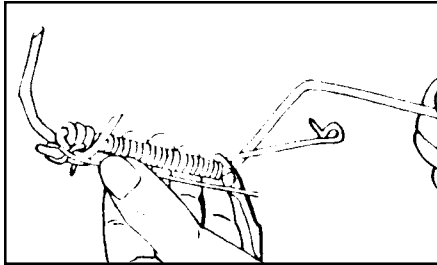
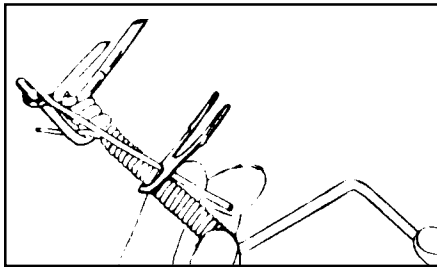

Fig. 12. Instructions for setting the Death-Klutch 1 gopher trap.

Pull thumb latch away from body shaft counter-clockwise (putting tension on spring), releasing from shipping position. Twist thumb clockwise until thumb latch stops.



With jaws in open position (as shown), hook crooked end of trip lever over top of left jaw with long end under jaw. Push top of trip lever toward spring.



Slide flat metal piece toward jaws with points up. Put trip lever through large hole and move flat metal piece up about 1 inch.

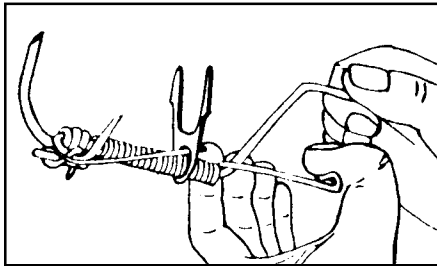

To apply spring tension, hold body shaft in right hand, catch thumb latch with left fore and middle fingers under spring. Hold firm and crank body shaft clockwise one turn, and hook thumb latch back to body shaft. Caution: wear gloves as finger may touch end of trip lever. If this becomes a problem, trim tail of trip lever slightly.

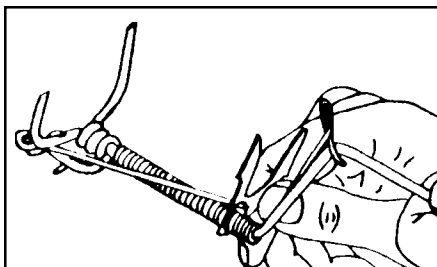

Move flat metal piece to ear (away from jaws) near tip end of trip lever. Trap is now ready to place into burrow.

have success leaving tunnels completely open when they set their traps; others, when they place traps in the main, close off the tunnel completely, and when trapping the lateral, close most of the tunnel with sod. Traps can be marked above ground with engineering flags and should be anchored with a stake and wire or chain so a predator does not carry off the catch and the trap.

Trapping can be done year-round because gophers are always active, but a formidable effort is required for trapping when the soil is frozen. Trapping is most effective when gophers are pushing up new mounds, generally in spring and fall. If a trap is not visited within 48 hours, move it to a new location. Leave traps set in a tunnel system even if you have trapped a gopher in spring and early summer, when gophers are most likely to share their quarters.

Shooting

Since pocket gophers spend essentially all their time below ground, this method is impractical.

Other Methods

Buried utility cables and irrigation lines can be protected by enclosing them in various materials, as long as the outside diameter exceeds 2.9 inches (7.4 cm). Gophers can open their mouths only wide enough to allow about a 1-inch (2.5-cm) span between the upper and lower incisors. Thus, the recommended diameter presents an essentially flat surface to most pocket gophers. Cables can be protected in this manner whether they are armored or not. Soft metals such as lead and aluminum used for armoring cables are readily damaged by pocket gophers if the diameters are less than the suggested sizes.

Buried cables may be protected from gopher damage by surrounding the cable with 6 to 8 inches (15 to 20 cm) of coarse gravel. Pocket gophers usually burrow around gravel 1 inch (2.5 cm) in diameter, whereas smaller pebbles may be pushed to the surface.

traps are set in the main tunnel or in the lateral tunnels (Fig. 13). To locate traps in the main tunnel, refer to the section on hand baiting. To locate the lateral tunnels, find a fresh mound and with a trowel or shovel, dig several inches away from the mound on the

plug side. The lateral may be plugged with soil for several inches (cm) or several feet (m). However, fresh mounds are usually plugged only a few inches.

You may have to experiment with trap type and placement. Some trappers

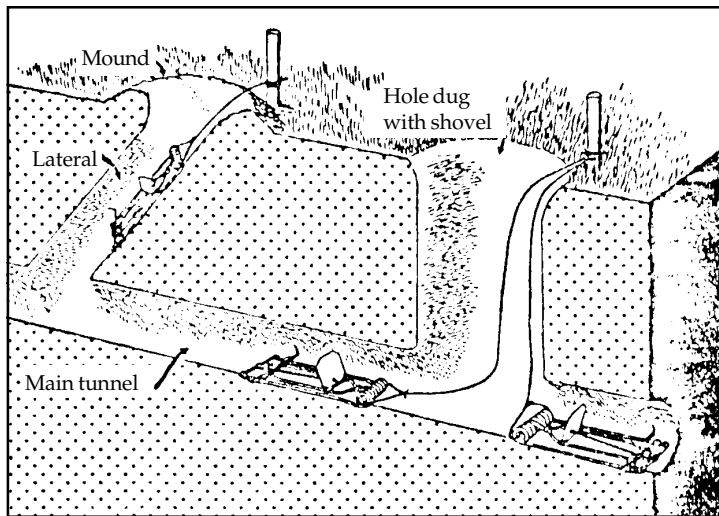

Fig. 13. Trap placement in lateral or main pocket gopher tunnels. Note that traps are staked.

Economics of Damage and Control

It is relatively easy to determine the value of the forage lost to pocket gophers. Botta's pocket gophers at a density of 32 per acre (79/ha) decreased the forage yield by 25% on foothill rangelands in California, where the plants were nearly all annuals. Plains pocket gophers reduced forage yield on rangelands in western Nebraska by 21% to 49% on different range sites. Alfalfa yields in eastern Nebraska were reduced as much as 46% in dryland and 35% in irrigated alfalfa. Losses of 30% have been reported for hay meadows.

Calculating the cost of control operations is only slightly more complicated. However, the benefit-cost analysis of control is still not straightforward. More research data are needed on managing the recovery of forage productivity. For example, should range be fertilized, rested, or lightly grazed? Should gopher mounds on alfalfa be lightly harrowed? A study of northern pocket gopher control on range production in southern Alberta indicated that forage yields increased 16%, 3 months after treat-

ment. The potential for complete yield recovery the first year following gopher removal has been noted for a fibrous-rooted variety of alfalfa.

Economic assessment should also be made to determine the cost of no control, the speed of pocket gopher infestation, and the costs associated with dulled or plugged mowing machinery or mechanical breakdowns caused by the mounds. Assessment could also be made for damages to buried cable, irrigation structures, trees, and so on.

The benefits of pocket gophers also complicate the economic analysis. Some of these benefits are: (1) increased soil fertility by adding organic matter such as buried vegetation and fecal wastes; (2) increased soil aeration and decreased soil compaction; (3) increased water infiltration and thus decreased runoff; and (4) increased rate of soil formation by bringing subsoil material to the surface of the ground, subjecting it to weathering.

Decisions on whether or not to control gophers may be influenced by the animals' benefits, which are long-term and not always readily recognized, and the damage they cause, which is obvious and sometimes substantial in the short-term. Landowners who are

currently troubled by pocket gophers can gain tremendously by studying the gophers' basic biology. They would gain economically by learning how to manage their systems with pocket gophers in mind, and aesthetically by understanding how this interesting animal "makes a living."

The distribution of gophers makes it unlikely that control measures will threaten them with extinction. Local eradication may be desirable and cost-effective in some small areas with high-value items. On the other hand, it may be effective to simply reduce a population. There are also times when control is not cost-effective and therefore inadvisable. Complete control may upset the long-term integrity of ecosystems in a manner that we cannot possibly predict from our current knowledge of the structure and function of those systems.

Acknowledgments

We thank the many researchers and managers who have spent untold time studying these extremely interesting rodents. Some are listed in the reference section. Special thanks are due to Scott Hygnstrom for his editorial assistance; to Rex E. Marsh, Bob Timm, and Jan Hygnstrom for their helpful comments on an earlier draft, and to Diane Gronewold and Diana Smith for their technical assistance.

Figures 1, 2, and 6 from Schwartz and Schwartz (1981).

Figures 3 and 5 from Turner et al. (1973).

Figures 4a, 4b, and 4c after Hegdal and Harbour (1991), adapted by Bruce Jasch and Dave Thornhill.

Figures 7, 8, and 10 by Jill Sack Johnson.

Figure 9 courtesy of Elston Equipment Company.

Figure 11 courtesy of Z. A. Macabee Gopher Trap Company.

Figure 12 courtesy of P-W Manufacturing Company.

Figure 13 adapted from E. K. Boggess (1980), "Pocket Gophers," in *Handbook on Prevention and Control of Wildlife Damage*, Kansas State University, Manhattan.

Table 1 taken from Marsh and Cummings (1977).

For Additional Information

- Alsager, D. E., ed. 1970. Control of pocket gophers. Alberta Department of Agriculture, Publication No. 686, 16 pp.
- Alsager, D. E. 1977. Impact of pocket gophers (*Thomomys talpoides*) on the quantitative productivity of rangelands vegetation in southern Alberta: A damage assessment tool. Pages. 47-57 in W. B. Jackson, and R. E. Marsh, eds. Test methods for vertebrate pest control and management materials, ASTM STP 625, Am. Soc. Testing Mater. Philadelphia, Pennsylvania.
- Andersen, D. C. 1978. Observations on reproduction, growth, and behavior of the northern pocket gopher (*Thomomys talpoides*). J. Mammal. 59:418-422.
- Anthony, R. M., V. G. Barnes, Jr., and J. Evans. 1978. "Vexar" plastic netting to reduce pocket gopher depredation of conifer seedlings. Proc. Vertebr. Pest Conf. 8:138-144.
- Barnes, V. G., Jr. 1973. Pocket gophers and reforestation in the Pacific Northwest: a problem analysis. US Fish Wildl. Serv. Special Sci. Rep. Wildl. No. 155. Washington, DC. 18 pp.
- Chase, J. D., W. E. Howard, and J. T. Roseberry. 1982. Pocket gophers. Pages. 239-255 in J. A. Chapman and G. A. Feldhamer, eds. Wild mammals of North America: biology, management, and economics. The Johns Hopkins Univ. Press, Baltimore, Maryland.
- Connolly, R. A., and R. E. Landstrom. 1969. Gopher damage to buried cable materials. Mater. Res. Standards 9:13-18.
- Corbet, G. B., and J. E. Hill. 1986. A world list of mammalian species. 2d ed. Facts On File Publ., New York. 254 pp.
- Downhower, J. F., and E. R. Hall. 1966. The pocket gopher in Kansas. Univ. Kansas Museum Nat. Hist., Misc. Publ. No. 44. 32 pp.
- Fitch, H. S., and J. R. Bentley. 1949. Use of California annual-plant forage by range rodents. Ecology. 30:306-321.
- Foster, M. A., and J. Stubbendieck. 1980. Effects of the plains pocket gopher (*Geomys bursarius*) on rangelands. J. Range Manage. 33:74-78.
- Hegdal, P. L., and T. A. Gatz. 1976. Hazards to wildlife associated with underground strychnine baiting for pocket gophers. Proc. Vertebr. Pest Conf. 7:158-266.
- Hegdal, P. L., and A. J. Harbour. 1991. Pocket gophers. Pages 5-19 in Prevention and control of animal damage to hydraulic structures. United States Printing Office, Denver, Colorado.
- Hickman, G. C. 1977. Geomyid interaction in burrow systems. Texas J. Sci. 29:235-243.
- Hickman, G. C. 1977. Swimming behavior in representative species of the three genera of North American geomyids. Southwest Nat. 21:531-538.
- Howard, W. E. 1961. A pocket gopher population crash. J. Mammal. 42:258-260.
- Kennerly, T. E., Jr. 1958. Comparisons of morphology and life history of two species of pocket gophers. Texas J. Sci. 10:133-146.
- Laycock, W. A., and B. Z. Richardson. 1975. Long-term effects of pocket gopher control on vegetation and soils of a subalpine grassland. J. Range Manage. 28:458-462.
- Luce, D. G., R. M. Case, and J. Stubbendieck. 1980. Food habits of the plains pocket gopher on western Nebraska rangelands. J. Range Manage. 33:129-131.
- Luce, D. G., R. M. Case, and J. L. Stubbendieck. 1981. Damage to alfalfa fields by plains pocket gophers. J. Wildl. Manage. 45:258-260.
- Marsh, R. E. 1992. Reflections on current (1992) pocket gopher control in California. Proc. Vertebr. Pest Conf. 15:289-295.
- Marsh, R. E., and M. W. Cummings. 1977. Pocket gopher control with mechanical bait applicator. Coop. Ext., Div. Agric. Sci., Univ. California Leaflet 2699. 7 pp.
- Miller, M. A. 1957. Burrows of the Sacramento Valley pocket gopher in flood-irrigated alfalfa fields. Hilgardia 26:431-452.
- Myers, G. T., and T. A. Vaughan. 1964. Food habits of the plains pocket gopher in eastern Colorado. J. Mammal. 45:588-598.
- Radwan, M. A., G. L. Couch, C. A. Harrington, and W. D. Ellis. 1982. Terpenes of ponderosa pine and feeding preferences by pocket gophers. J. Chem. Ecol. 8:241-253.
- Reichman, O. J., T. G. Whitham, and G. A. Ruffner. 1982. Adaptive geometry of burrow spacing in two pocket gopher populations. Ecology. 63:687-695.
- Schwartz, C. W., and E. R. Schwartz. 1981. The wild mammals of Missouri, rev. ed. Univ. Missouri Press, Columbia. 356 pp.
- Sudaman, P. D., J. C. Burns, and J. R. Choate. 1986. Gestation and postnatal development of the plains pocket gopher. Texas J. Sci. 38:91-94.
- Turner, G. T., R. M. Hansen, V. H. Reid, H. P. Tietjen, and A. L. Ward. 1973. Pocket gophers and Colorado mountain rangelands. Colorado State Univ. Exp. Stn. Bulletin 554S. 90 pp.
- Vaughan, T. A. 1962. Reproduction in the plains pocket gopher in Colorado. J. Mammal. 43:1-13.

Editors

Scott E. Hygnstrom
Robert M. Timm
Gary E. Larson

